



Puertas & Portones Automáticos, S.A. de C.V.
¡Nuestra pasión es la Solución!....

» FOTOCELDA INFRAROJA TX-RX 14MTS 24VDC WOLF ELECTRONICS MOD.BEAM-14M



MANUAL DE INSTALACION

CÓDIGO	SKU	MODELO	DESCRIPCION
MF-00020-00	DS-045	BEAM-14M	FOTOCELDA INFRAROJA TX-RX 14MTS 24VDC

VERSIÓN 1
FEBRERO 2019



(229) 288-1552

portonesautomaticos@adsver.com.mx
portonesautomaticos@prodigy.net.mx



(229) 927-5107, 167-8080, 167-8007, 151-7529.

www.adsver.com.mx

Las frecuencias por debajo de 433 MHz están prohibidas en Europa. Solo se permiten en países donde están autorizadas y que no pertenecen a la UE. Cualquier uso o manejo de estas frecuencias es responsabilidad del comprador.

En cumplimiento de la DIRECTIVA 2014/53/EU

FABRICADO POR /FAB: ESB06450563

MANUAL TX NEW CLONER

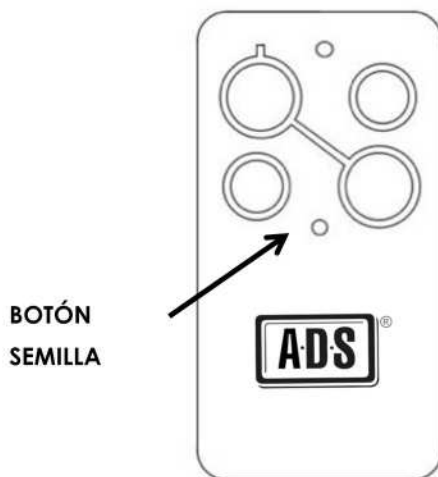

CARACTERÍSTICAS TÉCNICAS

- ✓ Modelo TX NEW CLONER
- ✓ 1 Batería 2032(3V)
- ✓ Frecuencia de 433,92 a 900 Mhz
- ✓ 4 Canales
- ✓ Chip especial
- ✓ Software patentado New Cloner

ATENCIÓN, ESTE MANDO TIENE DOS MODOS DE TRABAJO:

1. ENTRADA DIRECTA EN EL RECEPTOR
2. CLON

ATENCIÓN: EN EL TX NEWCLONER (MULTICLONER) SE PUEDE PONER UNA MARCA Y UNA FRECUENCIA DIFERENTE EN CADA BOTÓN (CANAL) SOLO EN MODO CLON.

MODO DE ENTRADA DIRECTA EN EL RECEPTOR

INSTRUCCIONES DE PROGRAMACIÓN

1. Localizar el selector DIP en el interior del mando. Hacer palanca para separar la carcasa mediante la pestaña de la cara inferior según la imagen de abajo.
2. Seleccionar la combinación en el DIP para la marca elegida. Ir a la tabla 1.
3. El mando está listo para ser usado. Consultar el manual de usuario del receptor.

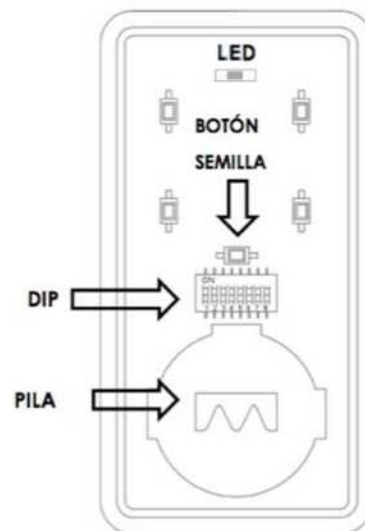
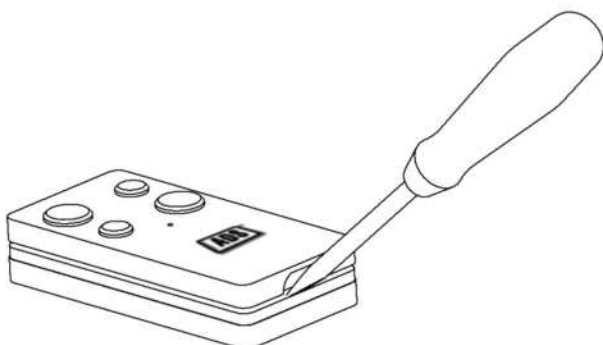



Nota: Para BFT, MUTANCODE y ERREKA es necesario presionar el botón oculto (con un clip u objeto pequeño) antes de pulsar un botón (botones del 1 al 4).

Tabla 1: Entrar directamente en el receptor.

Num	DIP SWITCHES	R/F	Brand Marca	Original	Comments Comentarios
1	<p>1 2 3 4 5 6 7 8</p> 	Rolling Code	Compatible con APRIMATIC TR 433.92 MHZ		
2	<p>1 2 3 4 5 6 7 8</p> 	Fixed Code	Compatible con APRIMATIC TR 433.92 MHZ		
3	<p>1 2 3 4 5 6 7 8</p> 	Rolling Code	Compatible con BENINCA TO GO WV / WP T WV / WK CUPIDO 433.92 MHZ		
4	<p>1 2 3 4 5 6 7 8</p> 	Rolling Code	Compatible con BFT MITTO 433.92 MHZ		Hidden button Botón semilla
5	<p>1 2 3 4 5 6 7 8</p> 	Rolling Code	Compatible con/with CARDIN S449-QZ2 433.92 MHZ		





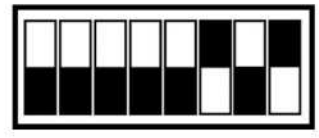
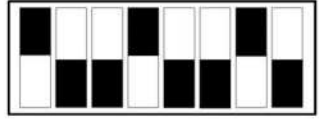

MANUAL DE INSTALACION

6	<p>1 2 3 4 5 6 7 8</p> 	Rolling Code	<p>Compatible con/with CENTURION 433.92 MHZ</p>		
7	<p>1 2 3 4 5 6 7 8</p> 	Rolling Code	<p>Compatible con/with DEA (KING SISTEM) GENIE GENIE GREEN GENIE WOOD MIO TR-2 433.92 MHZ</p>		
8	<p>1 2 3 4 5 6 7 8</p> 	Fixed Code	<p>Compatible con/with DITEC GOL4 GOL4C BIXLP2 433.92 MHZ</p>		
9	<p>1 2 3 4 5 6 7 8</p> 	Rolling Code	<p>Compatible con/with DOORHAN 433.92 MHZ</p>		
10	<p>1 2 3 4 5 6 7 8</p> 	Rolling Code	<p>Compatible con/with EMFA 433.92 MHZ</p>		

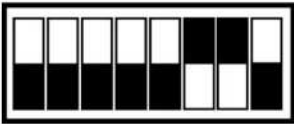
11	<p>1 2 3 4 5 6 7 8</p> 	Rolling Code	<p>Compatible con ERREKA SOL R SOL4R 433.92 MHZ</p>		Hidden button Botónsemilla
12	<p>1 2 3 4 5 6 7 8</p> 	Rolling Code	<p>Compatible con/with FAAC XT 433 RC 433.92 MHZ</p>		Red LED LED rojo
13	<p>1 2 3 4 5 6 7 8</p> 	Rolling Code	<p>Compatible con/with GIBIDI DOMINO AU1600 433.92 MHZ</p>		
14	<p>1 2 3 4 5 6 7 8</p> 	Fixed Code	<p>Compatible con/with KEY TXB-42 433.92 MHZ</p>		
15	<p>1 2 3 4 5 6 7 8</p> 	Fixed Code	<p>Compatible con/with KINGATE STYLO4 MYO4 C 433.92 MHZ</p>		
16	<p>1 2 3 4 5 6 7 8</p> 	Encrypte d Code	<p>Compatible con/with LIFTMASTER BILLIONCODE 433.92MHZ</p>		
17	<p>1 2 3 4 5 6 7 8</p> 	Encrypte d Code	<p>Compatible con/with Liftmaster Chamberlain Lobas 433.92 MHZ</p>		

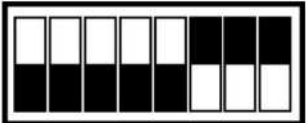
MANUAL DE INSTALACION

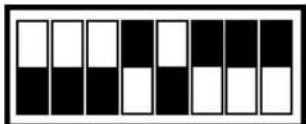
18		Encrypte d Code	Compatible con/with Liftmaster Chamberlain Motorlift 700 Lobas Raynor Orion 433.92 MHZ		
19		Fixed Code	Compatible con/with Marantec Twobi Raynor New England 433.92 mhz		
20		Rolling Code	Compatible con/with MCT-3 Linear 433 MHZ		
21		Fixed Code	Compatible con/with MOTOR LINE 433.92 MHZ		
22		Rolling Code	Compatible con/with MUTAN CODE 433.92 MHZ		Hidden button Botón semilla
23		Encrypte dCode	Compatible con/with NICE FLOR-S 433.92 MHZ		
24		Rolling Code	Compatible con/with NICESMILO 433.92 MHZ		

25	<p>1 2 3 4 5 6 7 8</p> 	Rolling Code	<p>Compatible con/with NOVOTROM NOVOFERM TORMATIC 433.92 MHZ</p>		
26	<p>1 2 3 4 5 6 7 8</p> 	Fixed Code	<p>Compatible con/with PRATEL MPSTF E MPSTP E TRQ P TC E 433.92 MHZ</p>		
27	<p>1 2 3 4 5 6 7 8</p> 	Fixed Code	<p>Compatible con/with PROTECO PTX433405 TX3 433.92 MHZ</p>		
28	<p>1 2 3 4 5 6 7 8</p> 	Rolling Code	<p>Compatible con/with PUJOL VARIO 1 OCEAN 433.92 MHZ</p>		Hidden button Botón semilla
29	<p>1 2 3 4 5 6 7 8</p> 	Fixed Code	<p>Compatible con/with AVANTI 433.92 MHZ</p>		

30	<p>1 2 3 4 5 6 7 8 1 2 3 4 5 6 7 8</p>	OPEN CODE	Compatible con/with ROLLTORE 433.92 MHZ		
31	<p>1 2 3 4 5 6 7 8</p>		Compatible con/with SOMFY 433 Mhz		
32	<p>1 2 3 4 5 6 7 8</p>	Rolling Code	Compatible con/with SOMMER 434.4 Mhz		
33	<p>1 2 3 4 5 6 7 8</p>	Rolling Code	Compatible con/with SOMMER 868.8 Mhz		
34	<p>1 2 3 4 5 6 7 8</p>	Fixed Code	Compatible con/with TELCOMA TANGO 433.92 Mhz		
37	<p>1 2 3 4 5 6 7 8</p>		Compatible con/with MEDVA		
38			GENIUS 433 Mhz		

MODO CLON

INSTRUCCIONES DE PROGRAMACIÓN

1. Localice el selector DIP en la parte frontal del mando **CLONER (TX NEWCLONER)**. Usar un destornillador para retirar la tapa frontal. Ver página 1.
2. Seleccione la posición de los DIP para la marca deseada. Ejemplo: Código fijo. LA combinación de DIPs para código fijo se muestra en la imagen inferior.

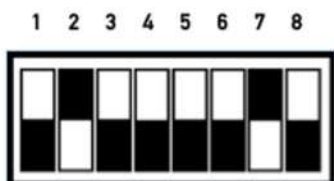

3. Pulse el botón 5 (botón oculto/semilla) del **CLONER (TX NEW CLONER)** localizado en el agujero que se encuentra debajo de los botones visibles. Esto activa el modo clon y se encenderá el LED del mando.
4. Presione UNA VEZ y SUELTE el botón de nuestro mando en el que desea utilizar el mando a clonar.
5. Acercar el mando **CLONER** al mando **ORIGINAL**.
6. Mantener pulsado el mando **ORIGINAL**. Si el procedimiento se ha realizado correctamente, el LED del mando **CLONER** emitirá 3 flashes.

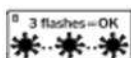







Para usar otro botón, repetir los pasos del 1 to 6.

TX NEW CLONER

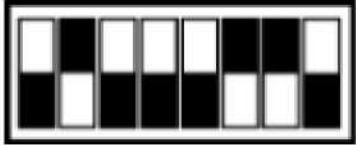
MODO CLON / CLONE MODE

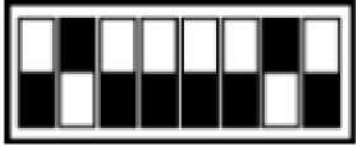
Num.	DIP SWITCHES	Brand Marca	Original	Comments Comentarios
1	<p>1 2 3 4 5 6 7 8</p>	Compatible con CLEMSA Mastercode.		
2	<p>1 2 3 4 5 6 7 8</p>	Compatible con DITEC		TXD
3	<p>1 2 3 4 5 6 7 8</p>	Compatible con JCM 868 MHz		STANDARD JCM

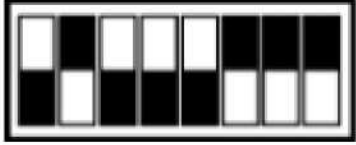
MANUAL DE INSTALACION

5	<p>1 2 3 4 5 6 7 8</p> 	<p>Compatible con V2 868 MHz 433 MHz</p>		<p>SCAN MODE Remote scans BOTH V2 433 MHz and 868 Mhz.</p> <p>MODO SCAN El <u>mando</u> <u>escanea</u> AMBOS <u>modelos</u> de V2, 433 MHz y 868 Mhz.</p>
6	<p>1 2 3 4 5 6 7 8</p> 	<p>Compatible con Universal Fixed Code</p>		<p>SCAN MODE Remote scans ANY fixed code remote.</p> <p>MODO SCAN El <u>mando</u> <u>escanea</u> CUALQUIER <u>mando</u> <u>código.fijo</u>.</p>
7	<p>1 2 3 4 5 6 7 8</p> 	<p>Compatible con Universal Rolling Code</p>		<p>SCAN MODE Remote scans ANY rolling code remote.</p> <p>MODO SCAN El <u>mando</u> <u>escanea</u> CUALQUIER <u>mando</u> <u>rolling code</u>.</p>