

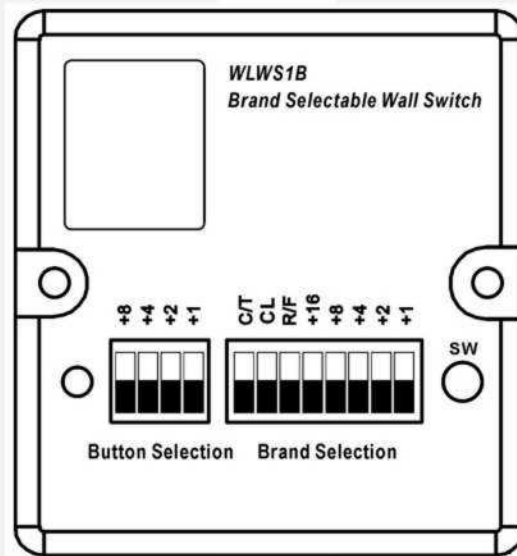

Puertas & Portones Automáticos, S.A. de C.V.
¡Nuestra pasión es la Solución!....

» BOTON DE PARED MULTI - FRECUENCIAS 1 CANAL MOD.WLWS1A-MULTI



MANUAL DE INSTALACION

CÓDIGO	SKU	MODELO	DESCRIPCION
MF-0007-00	WLWS1A-MULTI	WLWS1A-MULTI	BOTON INALAMBRICO D/PARED MULTI

VERSIÓN 1
AGOSTO 2016



(229) 288-1552

portonesautomaticos@adsver.com.mx
portonesautomaticos@prodigy.net.mx



(229) 927-5107, 167-8080, 167-8007, 151-7529.

www.adsver.com.mx

Manual for WLWS1A Wireless Wall Switch

WLWS1C WireLess Wall Switch was designed for wireless entry. With the dip switches, you can select most popular rolling code and fixed code remote in the world. With the button selection DIP switch, you can select the difference button combination for original remote compatibility.

WLWS1C also can work as clone mode. The most popular brand remotes can be cloned and work well same as the original one.

The brands and button combinations can be simply selected by move the difference dip position as the table.

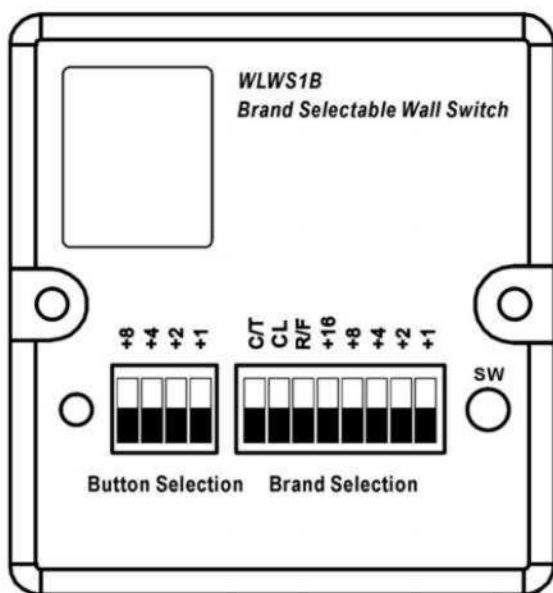

Brand selection

C/T: Copy/Transmit select

CL: CLone mode

R/F: Rolling code/Fixed code select

+16: brand counter +16

+8: brand counter +8

+4: brand counter +4

+2: brand counter +2

+1: brand counter +1

Button selection

+8: button position +8

+4: button position +4

+2: button position +2

+1: button position +1

SW: Hidden button for some brands

LED: the working indicator

1. Rolling code/Fixed code brand select.

Bit **R/F** is used for **Rolling** or **Fixed** code selection. At position down, the selection is for rolling code. At up, is for fixed code.

2. Brand selection.

Bit **+16**, **+8**, **+4**, **+2**, **+1** can make difference combination to select brands. All at down position, the selection is brand 0. Bit **+1** at up position, brand adds one, so is brand 1. Bit **+2** at up position, brands add two, so is brand 3. And so on. With these 5 dip switch, you can select from 0 up to $16+8+4+2+1 = 31$, totals 32 brands. So in the version, you can select the wall switch works up to 32 brands rolling code or 32 brands fixed code.

3. Button selection

Bit **+8**, **+4**, **+2**, **+1** can make difference combination to button.

Difference remote need difference button to select the receiver work channels. With these 4 dip switch, you can select from 0 up to $8+4+2+1 = 15$, totals 16 button combination, meet all possibility of the channel.



4. CL and C/T selection

The bit of **CL** is selector for Clone mode, this bit is at up position, the **WLWS1C** works as clone mode. The **C/T** bit select Copy or Transmit function. The **C/T** bit at up position, **WLWS1C** clone from original remote. At down position, **WLWS1C** work as transmitter, it work perfectly same as the original. With this mode, Bit **+16, +8, +4, +2, +1** for brand selection.

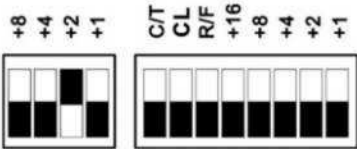
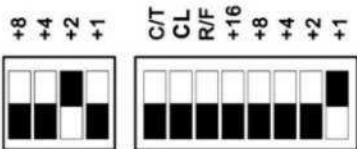
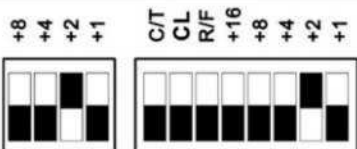
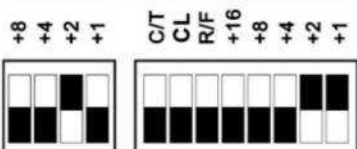
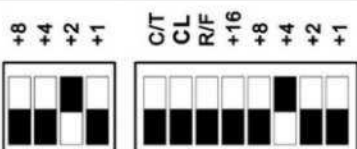
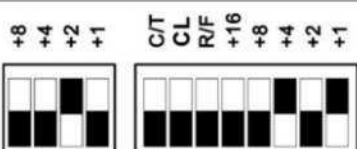
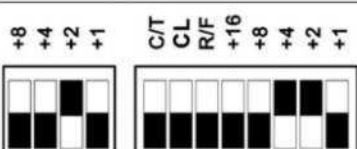
The tables for rolling and fixed code brands and buttons

Item	The dip switch selection	R/F	Brand	Buttons Valid	Remarks
1		Rolling code	BFT MITTO 433.92MHz	2/4/6/8	the SW button works same as hidden button
2		Rolling code	NICE SMILO 433.92MHz	2/4/6/8	
3		Rolling code	BENINCA 433.92MHz	2/4/6/8	
4		Rolling code	DEA 433.92MHz	2/4/6/8	
5		Rolling code	ERREKA Standard 433.92MHz	1/2/4/8	the SW button works same as hidden button It's standard installer code
6		Rolling code	GiBiDi 433.92MHz	2/4/8/C	
7		Rolling code	NOVOFERM MOVOTROM 433.92MHz	2/4/6/8	

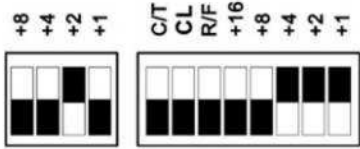
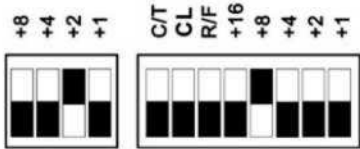
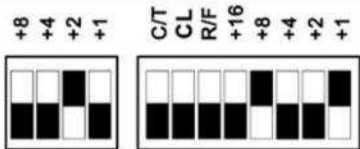
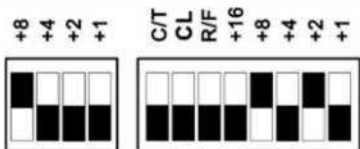
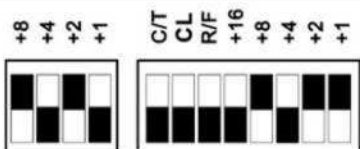
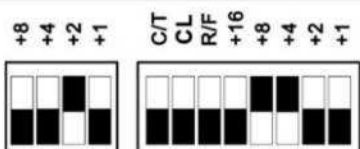
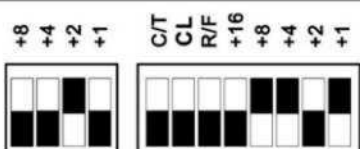
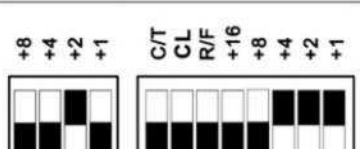
MANUAL DE INSTALACION

8		Rolling code	PUJOL VARIO 433.92MHz	2/4/6/8	
9		Rolling code	FAAC XT433RC 433.92MHz	2/4/6/8	
10		Rolling code	MUTAN CODE 433.92MHz	1/2/4/6	
11		Rolling code	DOORHAN 433.92MHz	1/2/4/8	
12		Rolling code	APRIMATIC 433.92MHz	1/5/8/A	
13		Rolling code	MAP 433.92MHz	2/4/6/8	
14		Rolling code	CENTURION 433.92MHz	2/4/6/8	
15		Rolling code	FOX 433.92MHz	2/4/6/8	
16		Rolling code	MAX EAGLE 433.92MHz	2/4/6/8	

1. The button and brand can be selected independently. The button selection are just for reference, not restricted as the table, can be selected from 0 to F.

MANUAL DE INSTALACION



Puertas & Portones Automáticos, S.A. de C.V.
¡Nuestra pasión es la Solución!...

Item	The dip switch selection	R/F	Brand	Button	Remarks
1		Fixed code	PROTECO 433.92MHz	0/2/4/5/ 8/9	
2		Fixed code	DITEC 433.92MHz	D/B/7/F	
3		Fixed code	MOTOR LINE 433.92MHz	4/5/6/7	
4		Fixed code	PRATEL 433.92MHz	1/2/4/8	
5		Fixed code	ROLTORE 433.92MHz	D/B/7/F	
6		Fixed code	NICE FLOW 433.92MHz	1/2/4/8	
7		Fixed code	KINGATE 433.92MHz	D/B/7/F	
9		Fixed code	KEY 433.92MHz	A/6/A/6	
10		Fixed code	ROGER 433.92MHz	1/2/4/8	

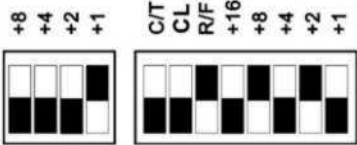
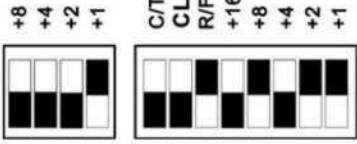
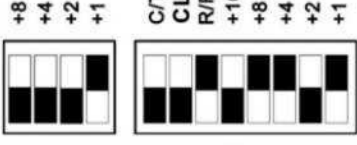
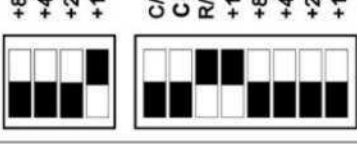
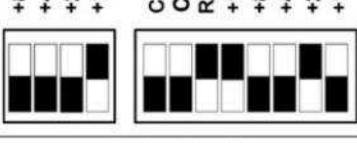
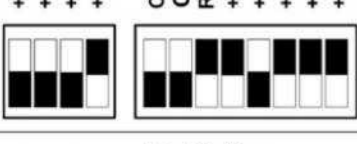
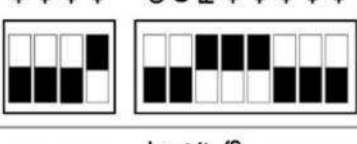
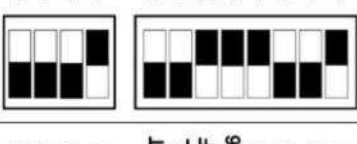
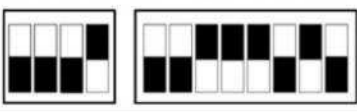
11		Fixed code	TANGO2 433.92MHz	1/2/4/8	
12		Fixed code	MARANTEC 433.92MHz	0/1/2/3	
		Encrypt code	Liftmaster Billion code 433.92MHz	0/1/2/3	
		Encrypt code	Liftmaster Motorlift 433.92MHz	C/D/E/F	
		Encrypt code	Liftmaster Lobas 433.92MHz	0/1/2/3	
		Encrypt code	V2 433.92MHz	1/2/3/4	
		Encrypt code	V2 868MHz	1/2/3/4	
		Rolling code	SOMMER 868MHz	1/2/4/8	
		Rolling code	Cardin 433.92MHz	1/2/4/8	

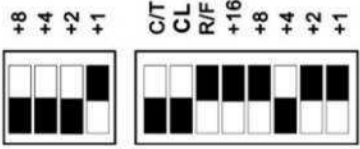
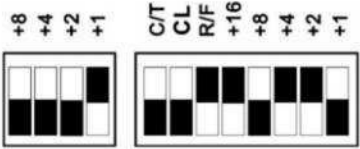
	Rolling code	SOMMER 433.92MHz	1/2/4/8	
	Rolling code	Linear 433.92MHz	1/2/4/8	
<ol style="list-style-type: none"> 1. The button and brand can be selected independently. The button selections are just for reference, not restricted as the table, all brands can be selected from 0 to F. 2. For some brands, the button will be changed because there're some encryptions in the remote. The buttons can be re-selected according to the certain brand. 3. Please sure the buttons is corresponding with receiver channels. 				

CLONE MODE

Put bit of **CL** at up position, the **WLWS1C** works as clone mode.



The **C/T** bit select Copy or Transmit function. The **C/T** bit at up position, **WLWS1C** clone from original remote.

At down position, **WLWS1C** work as transmitter, it work perfectly same as the original. With this mode, Bit **+16, +8, +4, +2, +1** for brand selection. The button selections are not available at clone mode.

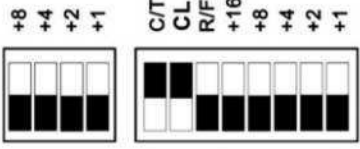
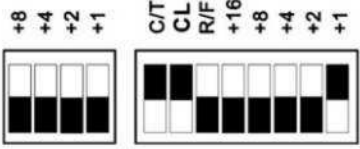
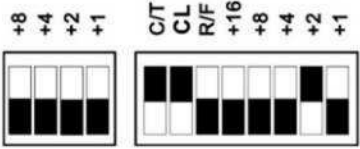
Clone mode brand table

Item	The dip switch selection	C/T	Brand	Buttons Valid	Remarks
1		Clone Mode	FAAC SLH 868MHz	Not Available	
2		Clone Mode	HORMAN MARANTEC FAAC 868MHz	Not Available	
3		Clone Mode	UNIVERSAL FIXED CODE 433.92MHz	Not Available	

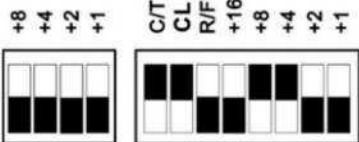
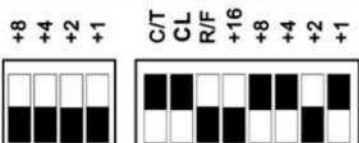
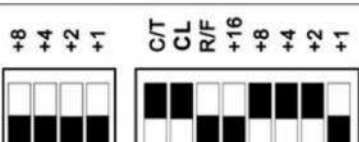
4		Clone Mode	DITEC 433.92MHz	Not Available	
5		Clone Mode	FAAC SLH 433.92MHz	Not Available	
6		Clone Mode	CLEMSA 433.92MHz	Not Available	
7		Clone Mode	MARANTEC 433.92MHz	Not Available	
8		Clone Mode	UNIVERSAL ROLLING CODE 433.92MHz	Not Available	
9		Clone Mode	V2 433.92MHz	Not Available	
10		Clone Mode	V2 868MHz	Not Available	
11		Clone Mode	UNIVERSAL FIXED CODE 306MHz	Not Available	
12		Clone Mode	UNIVERSAL FIXED CODE 310MHz	Not Available	

13		Clone Mode	UNIVERSAL FIXED CODE 315MHz	Not Available	
14		Clone Mode	UNIVERSAL FIXED CODE 330MHz	Not Available	
15		Clone Mode	UNIVERSAL FIXED CODE 390MHz	Not Available	
16		Clone Mode	UNIVERSAL FIXED CODE 318MHz	Not Available	

CLONE MODE Transmit

After clone successfully, put **C/T** dip at down position, **WLWS1C** work as transmitter, it work perfectly same as the original.

NOTICE:

1. The clones transmit brands can NOT be selected by the DIP switches. **WLWS1C** just work perfectly same as the brand while clone mode. All others DIP positions except **C/T** and **CL** are not available while clone transmit function.
2. The clone remote will be erased when another brand remote is cloned.